



ZURI[®]

PREMIUM DECKING BY ROYAL

Installation Guidelines



Table of Contents

Installation Guidelines	4
What is Zuri Decking?	5
Storage & Handling	6-7
Tools & Equipment	8-9
Design & Layout	10-13
Framing	14-15
Fasteners	16-17
Installation Process	18-23
Materials Checklist	24



Zuri® Installation Guidelines

Before installing any decking materials or stairway materials, review the following guidelines and installation instructions for proper installation procedure. Zuri® Decking has similar behavior to wood and composite decking; therefore, similar installation techniques should be used. In order to avoid improper installation, additional techniques, recommendations, and guidelines have been provided below. Following the provided instructions while using the same good building principals used in wood and composite decking installation will result in a correct Zuri® Decking installation.

Although Zuri® Decking is similar to wood and composite decking, it may not be appropriate for every application. Royal Building Products cannot be held liable for improper installation of Zuri® Decking. All deck structural framing should be built in accordance with local building codes. Many municipalities require decks to be designed by a local architect or engineer. It is recommended that you consult your local building code compliance office for any requirements. If you have any questions or need further assistance, please call 1.855.ROYAL85 or visit zuri.royalbuildingproducts.com.





What is Zuri Decking?

Trivance™ A new & unique Technology that combines Cellular PVC, Photorealistic Print, and Premium Acrylic to create a deck board like no other. A few key points:

- No resealing, staining or painting required
- Scratch resistant
- Fade resistant
- Moisture resistant
- Stain resistant
- Slip resistant

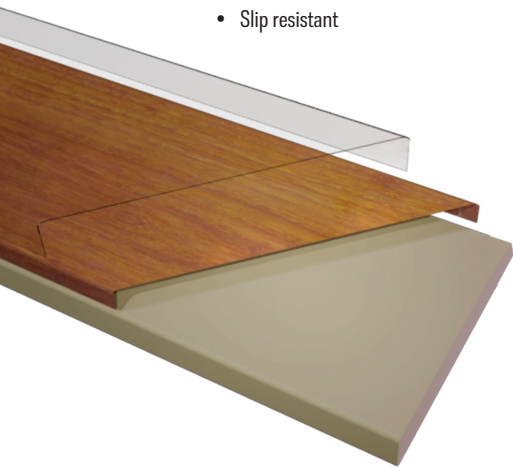

Storage & Handling

Material Storage

Zuri has been properly packaged from the manufacturer and should be stored and transported in this packaging until installation. The packaging also includes the arranging of the grain patterns to ensure pattern variation during the install, so the installer should work from one unit at a time.

- Leave protective shroud on decking material throughout the installation to avoid damage, protect from construction debris, and maintain a consistent board temperature.
- Store decking material on a flat surface to avoid bowing or warping (adjusting support blocks may be required on uneven ground).
- Use protective corner clips when banding to prevent stress damage to the decking material.
- Do not store in heat exceeding 120 °f.

Material Handling

Although Zuri has been developed with the Trivance™ Technology and has durable low maintenance features, special care is requested when handling these boards to minimize scuffs, nicks and to preserve the beauty of the finish. Think of the product as a prefinished wood in perspective to handling. A few key guidelines when moving and working with Zuri:

- **NEVER** dump Zuri prepackaged products when unloading.
- **Installing Zuri below 40°F is strongly discouraged (end coat & glue will not work properly).**
- When carrying product, use two people and stand board on its edge for better support.
- Avoid sliding the back of the product (Tan substrate) against the face (Clear protective coat) during the moving or working of the material. When removing product from packaging, lift the board as opposed to sliding on its edge.
- Avoid sliding or dragging tools and equipment during the construction process.
- Keep the work area clean and free from scrap or construction debris.
- After installation, protect deck from masonry dust, sheet rock dust, and other typical construction debris.
- **Zuri deck boards should be removed working horizontally across the unit, one layer at a time, installing every other board as illustrated. This will ensure grain pattern variation throughout the build. Be sure to always check the grain pattern before fastening the board.**

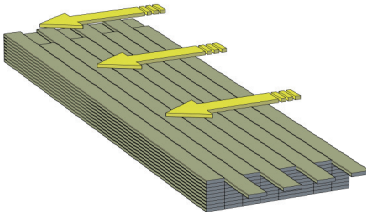

Tools & Equipment

Safety:

As with all construction projects, the proper safety equipment should be utilized at all times (ie safety glasses, hearing protection, gloves, etc.). Dust mask and long sleeves may be used if you are cutting in confined areas. Safe lifting practices should also be used when handling product as the weight and flex of the product can be awkward.

Tools:

Zuri has been created to have a finish comparable to that of interior hardwood flooring, with a durability and toughness to withstand the harsh outdoor elements. Therefore special attention is required when cutting and working with the product, the mind set should mimic that of working with any prefinished material. For this reason the tools required may be outside the scope of a conventional deck contractor and more in the realm of a finish carpenter. A list of tools:

Saws & Blades:

- 10" or 12" Miter Saw - Used for finished end-cuts and Trim miters
 - Minimum Blade requirements - Carbide 60 to 80 tooth
 - Blade recommendation - CMT 96 tooth fine finish (12")
- Jig Saw - used for cutting notches around obstacles, protrusions (ie posts, columns)
 - Minimum Blade requirements - 10 TPI
 - Blade recommendation - 10 TPI with board positioned Face Down
- Circular Saw or Portable Table Saw - Used for ripping deck boards
 - Minimum Blade requirements - Carbide Tooth - 24 T (7-1/4" blade) & 60T (10" blade)
 - Blade recommendation - (7-1/4") 60 T Skill Saw Carbide finishing (10") CMT 80 T Fine finish

Work Station:

It is recommended to use a miter saw stand, roller stands, or out feed tables when cutting Zuri decking and trims. The objective is to support the material during the cutting process.

Drills & Drivers:

Drills and drill bits as well as impact drivers and appropriate driver tips are required.

Layout Tools:

- Typical tools required such as tape, chalk line, straight edge, etc
- Plate Joiner - used for the EB-TY™ Fastener application
- CAMO™ Marksman Pro™ and Marksman Pro™ NB - tool provided with the Camo™ hidden fastening system



Design & Layout

Design Principles:

Due to the diversity of installation scenarios it is the installer's responsibility to determine the specific requirements for each application. Royal recommends that an architect, engineer or local building official review Zuri applications prior to install. The intent of the instructions is to set forth principles, work parameters, and provide a working knowledge of Zuri's characteristics.

Expansion/Contraction:

Expansion/Contraction: Expansion and Contraction are most significant where extreme temperature change exists. All PVC moves with temperature change and it moves differently from wood decking products. Wood will typically expand and contract in the width direction and Zuri will move in its length. Moisture has the biggest impact on Wood and no effect on Zuri's PVC substrate. The key to a successful build is planning for this lengthwise movement. A few ways to control movement are:

- Fasten boards within 1/2" of the ends.
- Minimum of 1/4" space between Zuri boards and any structure, post or obstruction.
- Upon cutting board to finished length, install as soon as possible.
- On long decks (20' and greater), orient the boards to run boards in the narrow direction. For example - on a 40' x 10' build, install 10' boards perpendicular instead of 20' boards parallel to the structure.

Zuri trims

Zuri Trim is designed as part of our Decking Solution and is required on all builds where the deck board ends would otherwise be exposed. The trim is designed to protect the ends of boards, provide transition solution and overall aesthetic. Best practices are:

- PVC glue all miter joints.
- Do not glue butt joints (to create an expansion joint).
- Face screw (HEADCOTE CAP-TOR Stainless Steel Deck Screws) only on the vertical side - use hidden fastener on the horizontal surface.
- Use a supporting block when cutting on Miter saw to ensure proper angle.

Zuri Coated Ends

Zuri requires all visible ends to be coated to conceal the lighter colored substrate. This is purely cosmetic, but it is required from an aesthetic perspective. Coating should be applied after cutting and prior to the installation of all boards. The coating colors are available in corresponding colors in an applicator from your Zuri Lumber Yard. If larger areas require coating such as fascias, framing, railing components we provide a color match (to end coat color) from Sherwin Williams below.

- Weathered Gray
Sherwin Williams: 2840 Hammered Silver
- Pecan
Sherwin Williams: 1112 Setter's Coat
- Walnut
Sherwin Williams: 1112 Setter's Coat
- Brazilia
Sherwin Williams: 6062 Rugged Brown
- Chestnut
Sherwin Williams: 6117 Smokey Topaz

Zuri Pattern Variation

Zuri provides different grain patterns. The product is packaged to aid in pattern variation, but installer must be mindful throughout the build to make certain pattern variation is maintained.

Rooftop & Patio Decks:

Zuri is a suitable and logical product for rooftop & patios (sunken framing) as long as the following principles are applied to the substructure (framing):

- Rooftop framing must be soundly attached to the roof or patio framing should be anchored (no floating framing)
- Framing – minimum joist height of 3-1/2"
- Framing – must be vented to allow heat to escape (ambient air should not exceed 160°f)

Venting illustrations

Layouts

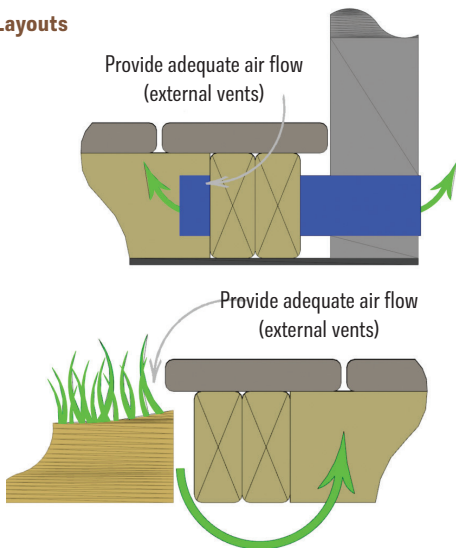

The layout or board orientation can have a big impact on the finished products appearance and perceived performance.

Points of consideration:

Staggered butt-joints - On runs exceeding 20' or unique builds that have need of butt-joints, additional framing is required to help control movement. Blocking or "Sistering" on each side of all butt joints is mandatory. The blocking must be screwed to mating frame tightly.

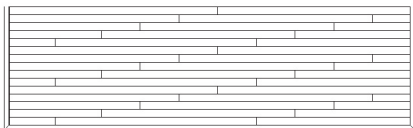
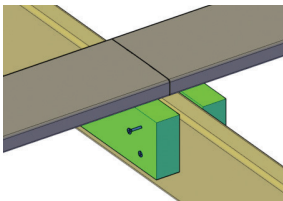

Feature board / Breaker board - This concept will disguise movement the best. By strategically placing a board perpendicular to the main build direction, this will simulate shorter runs and the perpendicular board moves very little in the width axis resulting in half the gap size of conventional joint.

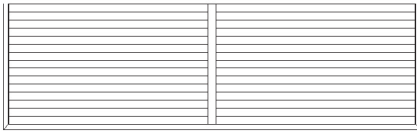
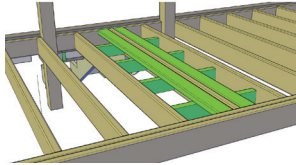

Inlays, borders and medallions - This concept, like the feature board, will aid in canceling the movement of Zuri. It is imperative that the framing is altered to accommodate design. Zuri cannot be cantilevered more than one inch.

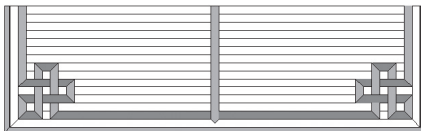
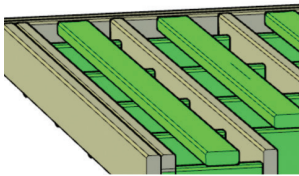

Framing

Building codes and/or officials should be consulted prior to Zuri installation to confirm structure conforms to local requirements. Zuri is load bearing, but should never be used for structural framing. The quality of the framing will directly impact the overall appearance of the Zuri decking as Zuri will conform to the shape of any uneven framing.

- We suggest framing with premium framing lumber. This wood is usually lighter, straighter and will not expand or contract as much during construction.
- Joist system must be level and flush.
- Install all railing posts or post supports prior to Zuri install. Railing supports must NOT be attached to Zuri Decking.
- Surface mounted railings cannot be mounted to or through Zuri.

Joist Spacing:

Cellular PVC is not as rigid or stiff as traditional hardwoods; Zuri boards are code approved for a 16" on-center installation. For a more rigid, firm, or wood like stiffness 12" on-center construction is recommended. 24" on-center is unacceptable for Zuri.

16" on-center - is permissible for standard residential applications. This only applies if boards are installed perpendicular to joists.

Additional cleat to support Zuri trim

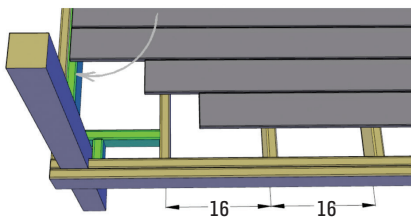

12" on-center - is required for high traffic areas, commercial builds and installs using a 45° or herringbone layout.

Additional cleat to support Zuri trim

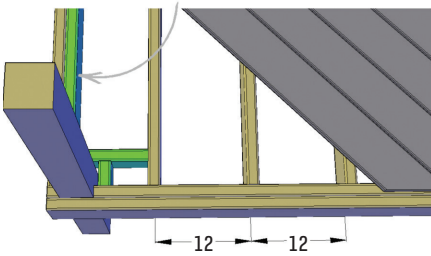

12" on-center - is required for all step stringers.

Additional cleat to support Zuri trim

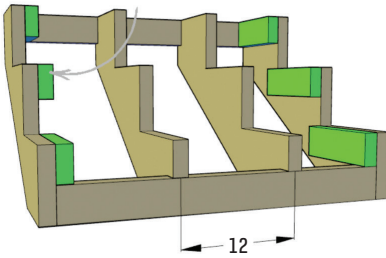

Fasteners

Hidden fasteners

Zuri is different from conventional wood, composite and other PVC decking products. The Trivance structure of Zuri requires face screws be kept to a minimum. All face screws on the horizontal plane ought to be placed in an inconspicuous location, namely against a structure, under trimmed areas, under handrails etc. Face Screws on the vertical plane, such as Zuri Trims, Risers of Fascia applications are acceptable. We have approved the following hidden fastening systems for installing Zuri:

Camo™ Marksman Pro - Gap size of 3/16"

Please follow the Camo™ installation instructions provided with the system. This method is a Toe-Screw application with the following attributes:

- Least expensive
- Fast
- Top performer in respect to restricting expansion / contraction movement
- Product design is very conducive to board replacement



EB-TY™ Original Series Hidden Deck fastening system - Gap size of 3/32"

This system requires a plate joiner or router to cut a slot in Zuri decking to accommodate a "Biscuit" shaped retainer that is screwed through the board into the framing. EB-TY will provide complete instructions with product,

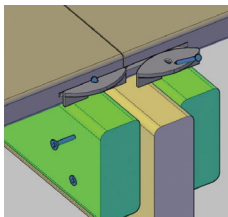

but an overview technique and key features are:

- Smallest gap size available
- Performed well in respect to restricting expansion / contraction movement
- Requires 1 fastener per sq/ft of decking

Headcote Cap-Tor - #10 x 2-1/2" Screws

Use to face-screw Zuri Trim. NOTE: 305 stainless for inland builds and 316 stainless for seaside or brackish water applications.

Approved for use with ACQ treated lumber

Available in color matched coating

Weathered Gray:
Tan Gray #31

Pecan: Cedar #81

Walnut: Brown #34

Brazilia: Mahogany #82

Chestnut: Buckskin #63

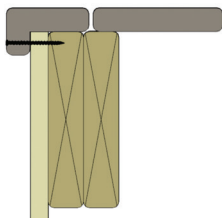

Star Recess



Auger Point

Installation Process

Installation progression

Zuri must be installed in the following sequence. This section will be divided in order of installation:

- Fascia / Skirt Board - Main body of build (DO NOT Clad stair risers at this point)
- Zuri Trim
- Main Body decking
- Steps and Landings

Step 1 - Fascia / Skirt board

All fascias should be installed prior to decking. We suggest using Royal's S4S trim products with Cortex™ style fasteners. Full installation instructions for this application are available at www.royalbuildingproducts.com. A few application specific guidelines are:

- Fascia must fully cover framing, as it will support the Zuri Trim
- All miter joints are to be glued - PVC cement
- Expansion joints are required on runs exceeding 20' - shi lap joint is recommended
- Required Fastening schedule for PVC Trim
- Boards 6" wide or less - 2 fasteners, 16" on center
- Boards 8" to 10" wide - 3 fasteners, 16" on center
- Boards 12" wide or more - 4 to 5 fasteners, 16" on center

Screw position - no less than 1/2" and no greater than 2" from edge of board

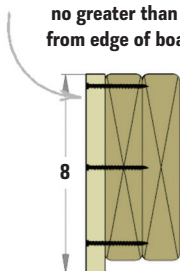

Shi lap Joint

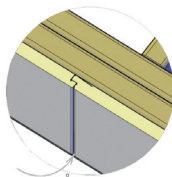

No glue on this joint

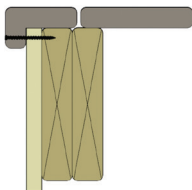

Step 2 - Zuri Trim

Install Zuri trim around the entire perimeter of the deck body. Do not trim steps at this time. The trim must be installed with a combination of face screws and one of the approved fastening systems. They follow techniques should be followed:

- Maintain straight lines and square corners as this will be starter for decking.
- When laying out the Zuri trim snap a chalk line 2 3/8" to 2 1/4" back from the fascia. This provides a space between the trim and the fascia allowing for expansion/ contraction and helps hide any framing inconsistencies.
- Use framing square, 3,4,5 method or cross measure to maintain square.
- Secure face with Headcote Cap-Tor - #10 x 2-1/2" Screws and hidden fastener on backside (see options below).
- All miter joints must be glued (PVC Cement).
- All miter joints must have an expansion joint within 6' to allow for movement.
- Paint all butt-ends on expansion joints (NO glue).
- Glue all miter-joints (NO Paint).

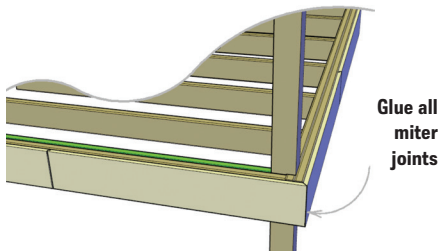

Eb-Ty Option

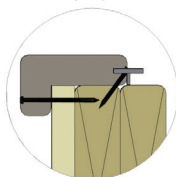

Camo Option

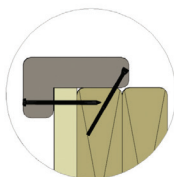

Step 3 - Zuri Main Body Decking

Install Zuri deck boards with one of the two approved fastening methods. Work from the trim side or highest traffic area toward the structure or least traffic area. Remember to monitor the grain patterns to guarantee grain variation. Feature boards, transition boards and/or inlay work should be installed first, and then the main body. This allows for more precise cutting.

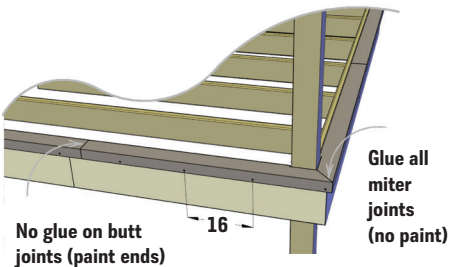

- Follow the selected fastening systems instructions
 - Camo provides 3/16" gap spacing
 - Eb-Ty provides 3/32" & 1/8" gap spacing

Blocking required on all butt joints

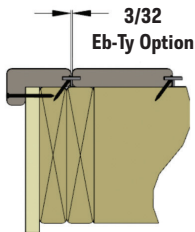
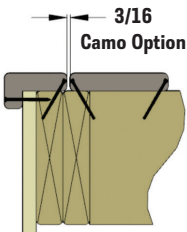
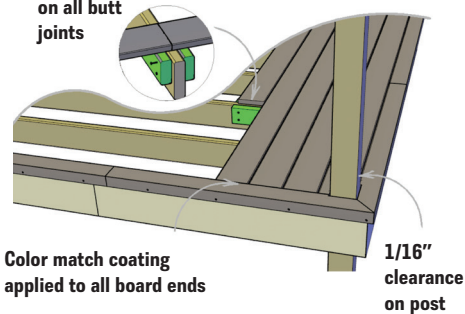

Step 4 - Steps

Zuri step installation is a bit different than conventional methods and requires the same attention to the installation sequence as the main deck. The following progression will be the order of install and each process must be completed before moving next. This section only covers the Decking / Fascia applications and presumes framing is complete.

1. Mount the fascia on the stringers and first riser.
 - Follow same guidelines listed in the Fascia / Skirt Board section
 - NOTE: Notch the stringer to accommodate the trims

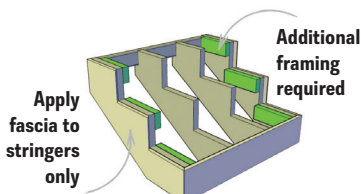
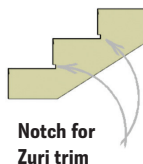

2. Attach Decking Boards.
 - Starting on the bottom step attach the Zuri trim board
 - Then install the deck boards starting from the trim and working back toward the stringers.
 - Face screw the back of the ripped board that rests against the stringers within 3/4" of the ripped edge (this way the screws will be covered by the risers)

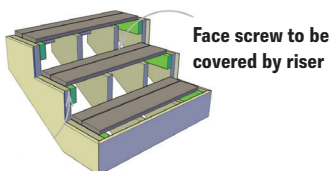
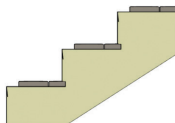

3. Attach Risers and Zuri Trim.

- Install the remaining risers
- Cut and pre-assemble the trims for each step.
- Install the assembled trims as directed in the trims section

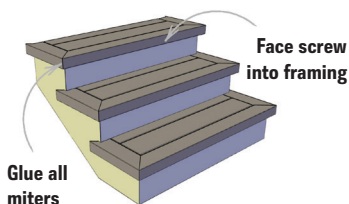
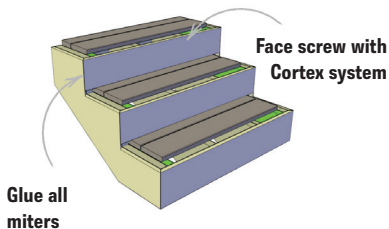

Tips & Techniques

Gluing Zuri® - Zuri's PVC substrate can be chemically welded with PVC glue. This bond is recommended on all miters and filler board applications. Best practices are:

- Use PVC cement in conjunction with 2P-10 instant adhesive (locations identified below) to speed the process and eliminate the need for clamping
 - Oatey - Heavy Duty - Clear PVC Cement
 - 2P-10 instant adhesive (available at www.fastcap.com)
- Pre-glue joint before installing
- Routing the ends of the Zuri boards is acceptable with a router no larger than 3/16"

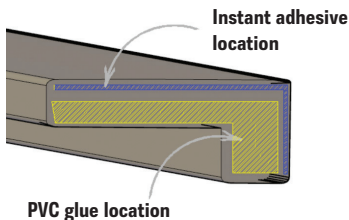

Align and hold for 10 to 15 seconds

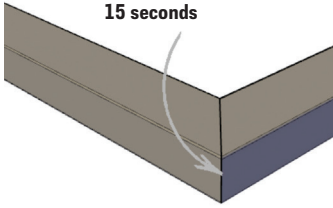

- Fascia mounted railing post with picture showing location of joints on trim

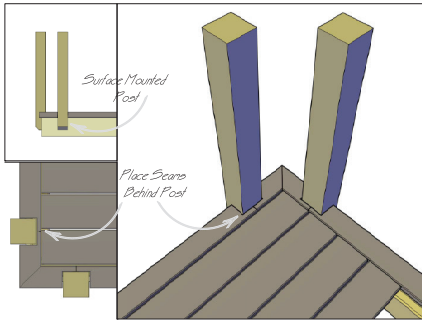

Materials Checklist



- Cap-top screws



- 2P-10 Activator and Glue



- Heavy-Duty PVC Cement



- End Coat Paint Applicator



- Camo Guns - Marksman Pro for deck boards and Camo Marksman NB for trimboards. Please note: Do not use the X-1. It places the holes too high.



Congratulations on your informed decision to install Zuri® Premium Decking by Royal. Your Zuri decking requires very little maintenance, but does require occasional attention to ensure a long, problem-free product life. The following pages contain important information on maintaining the beauty of your Zuri® Premium Decking



Maintaining the Beauty

Stains

The decking is highly resistant to stains from ketchup, mustard, sodas, punch, salad oil, barbeque sauce or other food products commonly found in a decking environment. When these stains or spills do occur, they should be cleaned quickly, within one week of the spill, using nothing more than a mild detergent and water. Left to dry for extended periods of time, these types of stains may become more difficult to remove. Should this occur, using mild detergent, water and scrubbing with a terry cloth rag, sponge or soft bristle brush should be sufficient to remove most stains. Stubborn stains may be removed by pressure washing with a maximum of 2700 psi and a 25 degree or greater cone nozzle. Excessive pressure with aggressive cone nozzles could cause damage to the board and void the warranty.

Products that have been tested and found safe to use on Zuri decking include:

- Soap and water
- Formula 409 Cleaner
- Spic and Span
- Mr. Clean Cleaner
- Mr. Clean Magic Eraser
- Soft Scrub Cleaner
- Glass Plus Cleaner
- Liquid Comet Cleaner
- Clorox Bleach
- Sodium Hydroxide
- Deck Max Cleaner
- Deck Max Revitalizer



Ice In Winter

Calcium chloride may be used to prevent or remove ice. Salt based products can leave behind a white deposit that can be easily cleaned with water. Use of steel implements such as shovels, rakes or picks can damage the deck and should never be used to remove ice, debris or other materials from your deck. Such use of steel implements will void the warranty.

Insect Repellent and Sunscreen

Some insect repellent and sun screen products have been found to leave a hard, clear, glossy coating similar to lacquer, paint, or polyurethane when allowed to dry over an extended period of time. This clear coating can become difficult to remove if allowed to dry. If feasible, please apply these products away from your deck area or place a towel or appropriate covering when applying as inadvertent overspray may damage the deck finish. If repellent or sunscreen does come in contact with the deck, clean immediately to reduce the risk of adhesion to the deck surface. Magic Eraser has been tested and works well to remove residue if used early (less than 24 hours).

Fasteners and Deck Framing

Fasteners and the framing structure should be inspected, at a minimum, semi-annually to ensure the boards are properly secured. If fasteners or the structure are found to be defective or damaged, repairs should be made immediately. Failure to inspect and maintain the framing structure and fasteners will void the warranty.



ZURI[®]

PREMIUM DECKING BY ROYAL

1.855.ROYAL85

zuri.royalbuildingproducts.com

 **ROYAL**[®] Building Products

0116